



\$P19231003\$Hpicking

**OSKAB**  
POUR TOUS

# Sachet charnières 110°

## Notice de montage

Retrouvez toutes les informations sur [www.oskab.com](http://www.oskab.com)

### Les outils

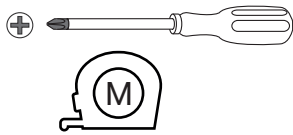

1 personne

### Contenu du sachet

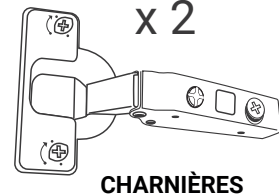

CHARNIÈRES

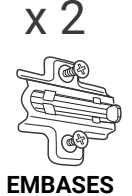

EMBASES

### Etape 1

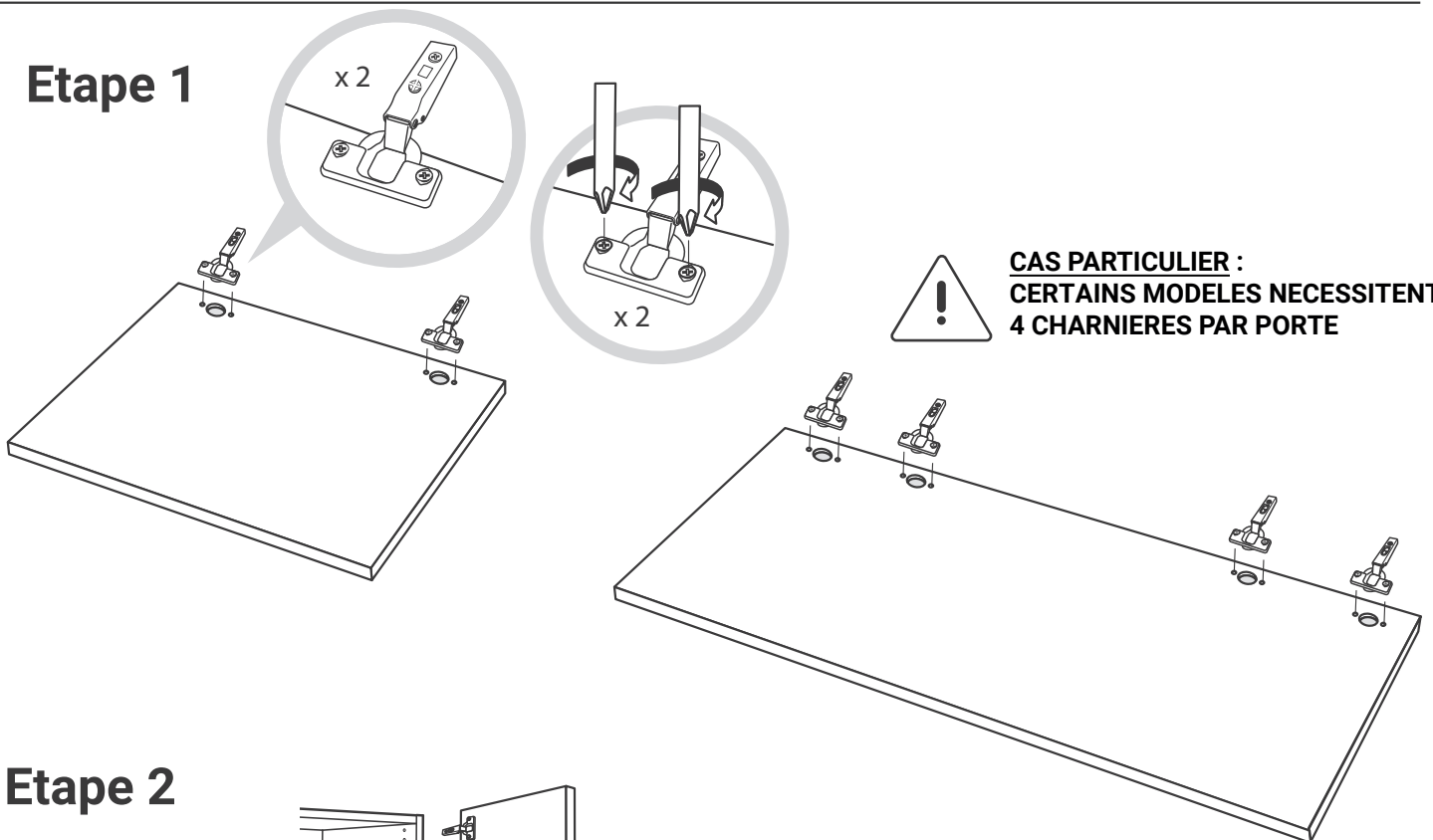

### Etape 2

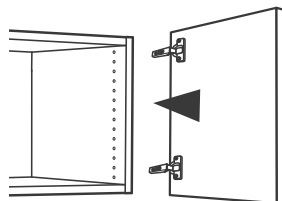

Pour identifier l'emplacement des embases sur le caisson, positionner la porte avec les charnières devant le caisson et repérer les trous concernés

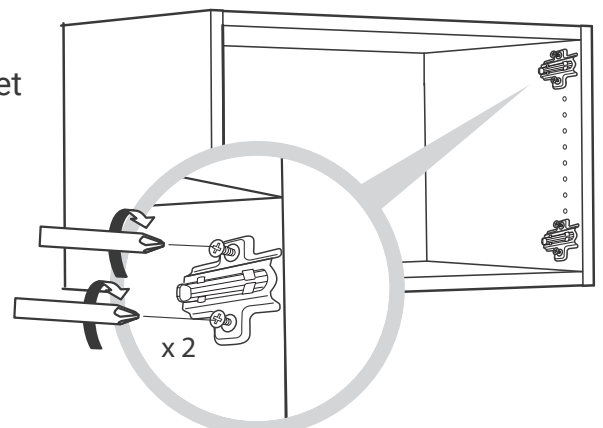
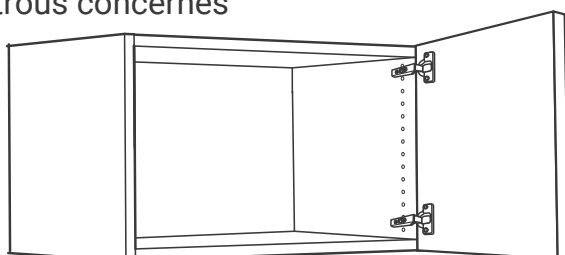

Partie la plus longue de l'embase vers le fond du meuble

# Etape 3

## Clipsage de la charnière sur l'embase



**CAS PARTICULIER : FAÇADE DE HAUTEUR 125 CM SANS PRISE DE MAIN INTEGREE**  
Comment reconnaître le sens de la porte?

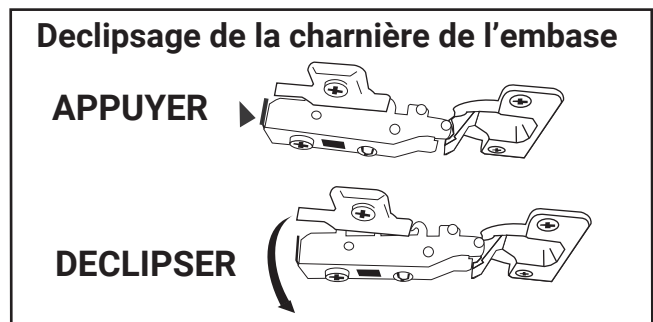
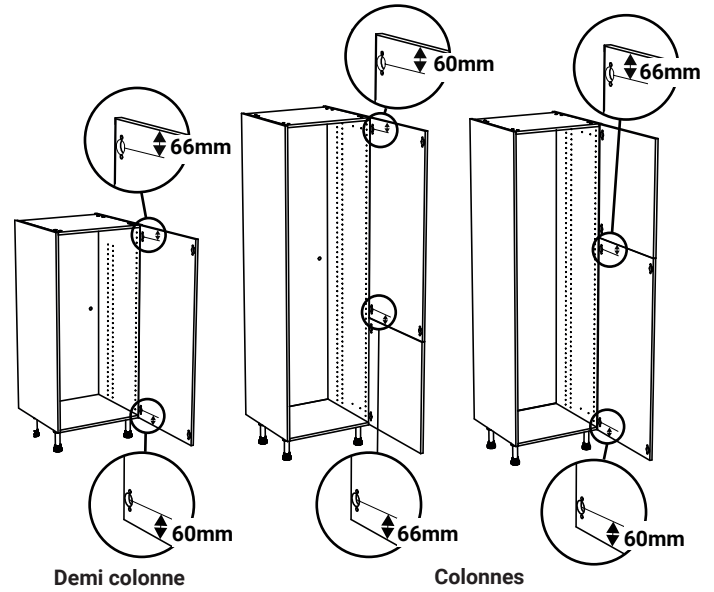
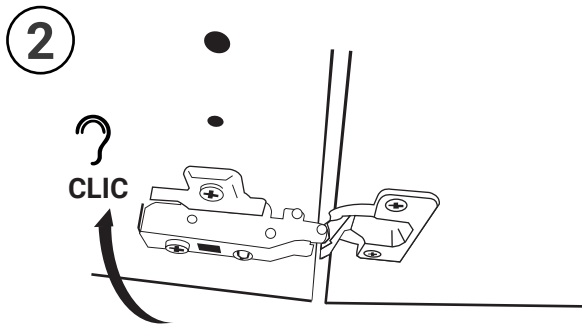
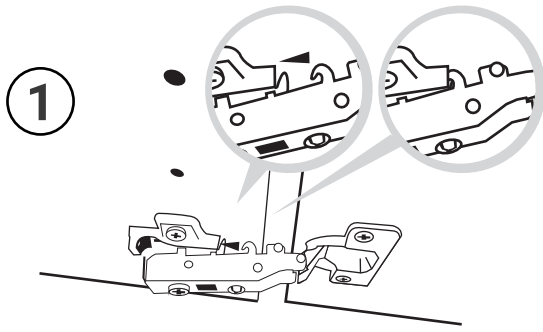

## Réglages

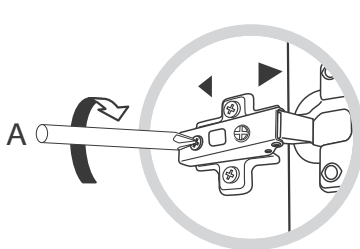

Desserrer/serrer pour ajuster la porte horizontalement

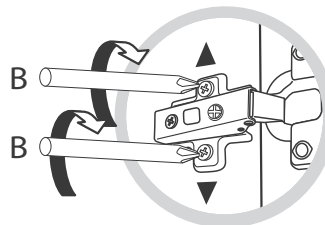
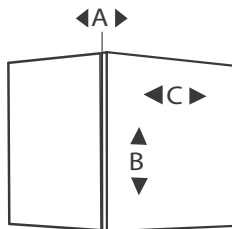

Desserrer, bouger, puis serrer pour ajuster la hauteur de la porte

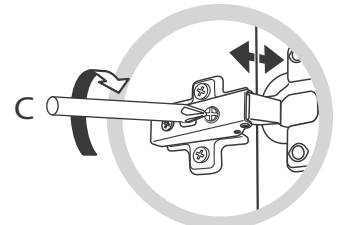

Desserrer, bouger, puis serrer pour ajuster l'écart porte/caisson

## Cas de tiroir à l'anglaise

prendre des charnières ouvrant à 165° pour laisser le tiroir sortir complètement

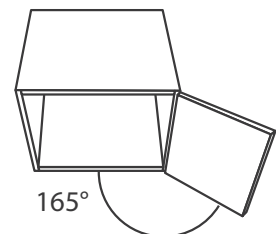
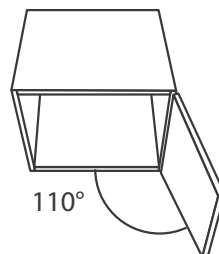

## La pose des poignées et boutons

Aidez vous du gabarit de perçage pour poser vos poignées et boutons sur vos façades de tiroirs.

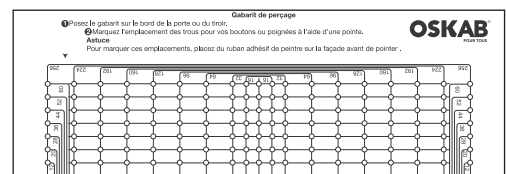

Retrouvez toutes les informations sur [www.oskab.com](http://www.oskab.com)